

ELECTRIC LOCKS

Europrofile range

WHY CHOOSE ABLOY ELECTRIC LOCKS?

Compared to other solutions like magnet locks or electric strikes, electric locks give long-lasting security that will not wear out. Still electric locking provides ultimate mechanical strength but uses power only while opening.

WITH ABLOY ELECTRIC LOCKS YOU GET

1. Wide product range
2. Complete solution
3. Energy saving
4. Safety with standards approvals
5. Aesthetic appearance
6. User friendliness
7. More functions

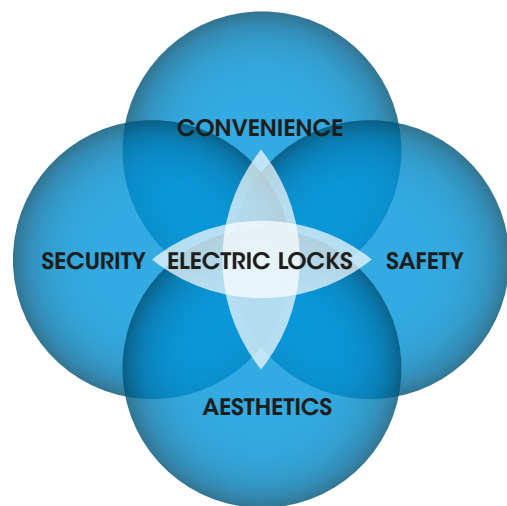

ABLOY ELECTRIC LOCKS FOR
DIFFERENT TYPES OF DOOR
ENVIRONMENTS

Lock types

page 4

Certa Motor locks

page 5

Handle controlled
solenoid locks

page 12

Push and Pull
solenoid locks

page 16

Mechanical/
Microswitch locks

page 17

ELECTRIC LOCKS

ABLOY electric locks have been manufactured over 40 years, since 1970's. ABLOY motor lock was the first of its kind in the world, and since then we have proudly presented the best electric locking solutions to all around the world. Today we can offer a whole range of electric locks to secure different types of door environments. DIN range locks are designed to match the regulations and dimensions of the European markets but are known and used all around the world.

WITH THESE SYMBOLS YOU CAN EASILY FIND THE RECOMMENDED PRODUCTS AND FEATURES OF EACH LOCK



HANDLE USED
indicates when handle is being pressed down



BOLT IN
indicates when deadbolt is retracted



BOLT OUT
indicates when deadbolt is completely drawn out and deadlocked



CYLINDER USED
indicates when key is turned inside the cylinder



DOOR CLOSED
indicates when trigger bolt is pressed in



CABLE SABOTAGE
Indicates when cable is cut



EN179 standard for emergency exit products, exit route can be equipped by handles.



EN1125 standard for panic exit products, exit route must be equipped with panic bars.



EN1634 standard for fire door products, defines the category of fire insulation.

The following standards apply to specific lock cases depending on the category of use. Exit standards require a lock case model with inside handle, push pad or panic bar that can always be used for safe exit.



CYLINDER



LEAD COVER



LOCK CASE



FITTINGS AND HANDLES



STRIKE PLATE



CABLE

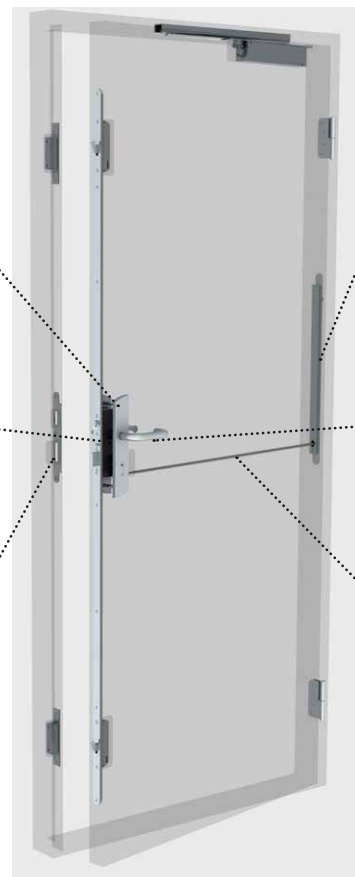

LOCK TYPES

Available in
two sets of
models



SINGLE POINT LOCK CASE



MULTIPOINT LOCK CASE

ABLOY electric lock product range is available in two sets of models, single point locks and multipoint locks. They both share the same functionality and type of use, as the middle locks of the multipoint locks are based on the single point locks.

You can recognize multipoint locks from the product code which in mechanical, microswitch and solenoid locks ends with digit 6 or 7, and in motor locks begins with MP.

AS EXAMPLE:

- EL566/EL567 are the multipoint versions of EL560/EL561
- MP520 is the multipoint version of EL520

MULTIPOINT LOCKS

With ABLOY multipoint lock cases the level of security and protection of doors is reached to higher level. Locking solution with three lock cases connected together to function as one gives the best support to doors from bending without losing any of the ease of use compared to single point lock cases.

ABLOY multipoint locks offer several functional options with comprehensive selection of status indications on one multipoint locking solution. In addition to increased security, they offer the same versatility as ABLOY single point lock cases.

Multipoint locks are available also with flat forend. This new shape opens more possibilities for clean-cut installations in different types of doors. This reduces the door gap and gives excellent protection against fire, smoke and burglaries.

CERTA RANGE - MOTOR LOCKS

APPLICATION

ABLOY CERTA Motor locks are used in doors that require:

- Convenience (push / pull function)
- Security (no handles outside)
- High durability (high traffic doors)
- Door automation and controlled access

FUNCTION

ABLOY CERTA Motor lock has two deadlocking bolts: a double action bolt and a dead bolt. The deadbolt is withdrawn inside the lock case by motor and the double action bolt is released, when electrical control is on. Locks are always automatically deadlocked when the door is closed.

CONTROL SWITCH

Momentary (Public and Hi-security):

Dead bolt is retained inside the lock case adjustable delay between 2 - 15 seconds.

Continuous (Small business, Public and Hi-Security):

Dead bolt is retained inside the lock case as long as electrical control is on.

When the door closes and the delay or electrical control is off, both bolts are deadlocked. In case of power failure the bolts are always deadlocked in categories Public (EL420, EL520) and Hi-Security (EL432, EL532). In category Small Business (EL418, EL518) the bolt remains its current position in case of power failure.

CERTA RANGE HI-SECURITY

Hi-Security category locks are suitable for electrically controlled fire rated doors requiring extremely high level of security. Unlike other lock cases Hi-Security locks can be used in day mode (free access by pushing or pulling), night mode (deadlocked but exit-handle enabled) and also in secure mode (deadlocked and inside handle disabled). The inside handle is electrically controlled but in case of emergency or power failure the locks can be opened by the inside handle. Mechanical opening by cylinder is always possible.



SINGLE POINT LOCK CASES

EL432, EL532

RECOMMENDED PRODUCTS



EA324



EA231



EA281



CY332T



DH006/
040 Ms/Cr

INDICATIONS



STANDARD APPROVALS



MULTIPOINT LOCK CASES

MP432, MP532

RECOMMENDED PRODUCTS



EA324/
EA306



EA231



EA281



CY332T



DH006/
040 Ms/Cr

STANDARD APPROVALS



SPECIAL MODEL FOR EXTRA HIGH SECURITY

EL532HS

RECOMMENDED PRODUCTS



LP764



EA231



EA281



CY332T



DH628

STANDARD APPROVALS

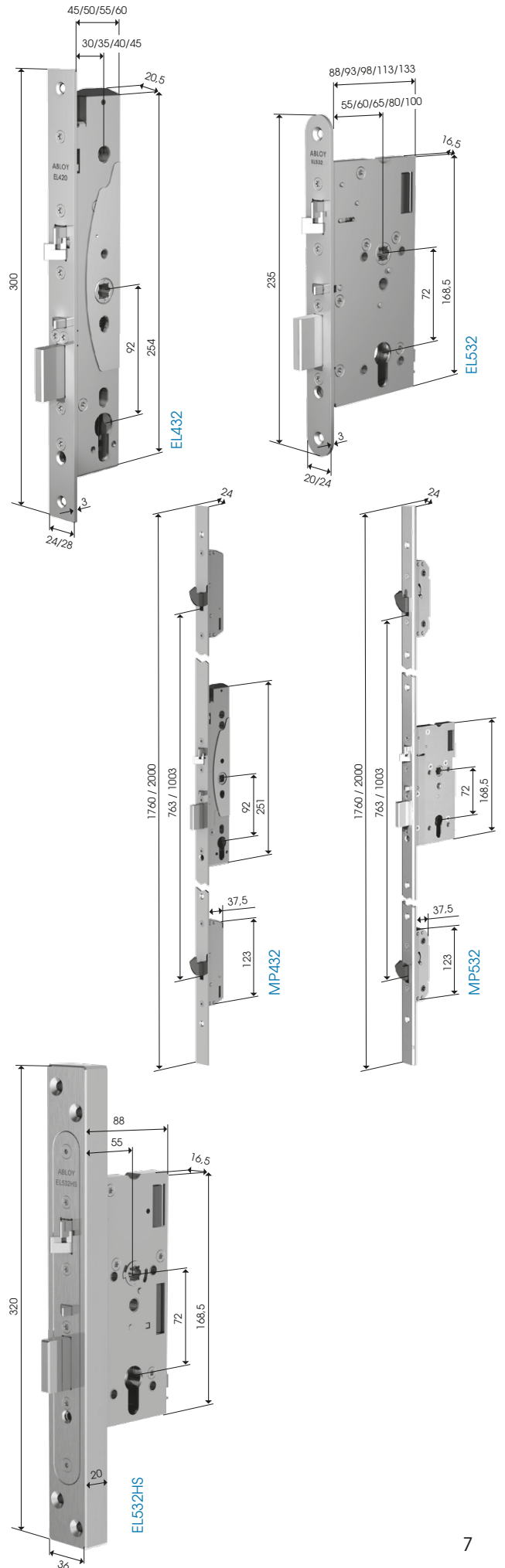

CERTA RANGE PUBLIC

The Public category locks are suitable for exit doors (EN179/ EN1125) and fire rated doors. Public range locks provide perfect combination of safety and security for number of different door environments. Locks can be used in day mode, where deadbolt is driven in giving free access and egress by pushing or pulling the door open. Other option is to use the lock in secure mode where the lock is automatically deadlocked when door is closed, but it can always be opened by inside handle. Mechanical opening by cylinder is also always possible.

SINGLE POINT LOCK CASES

EL420, EL520

RECOMMENDED PRODUCTS

				
EA324/ EA306	EA219	EA281	CY323T	DH006/ 040 Ms/Cr

INDICATIONS

					
---	---	---	---	---	---

STANDARD APPROVALS

		
---	---	---

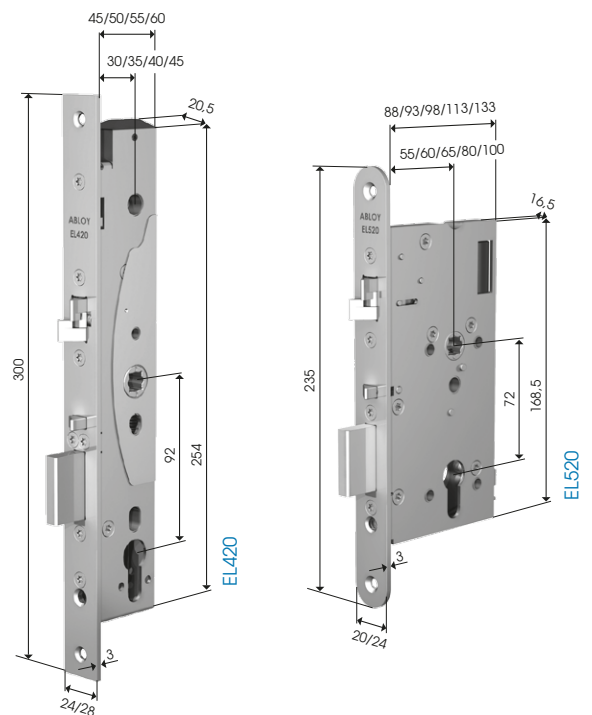

MULTIPOINT LOCK CASES

MP420, MP520

RECOMMENDED PRODUCTS

				
EA324/ EA306	EA219	EA281	CY323T	DH006/ 040 Ms/Cr

INDICATIONS

					
---	---	---	---	---	---

STANDARD APPROVALS

		
---	---	---

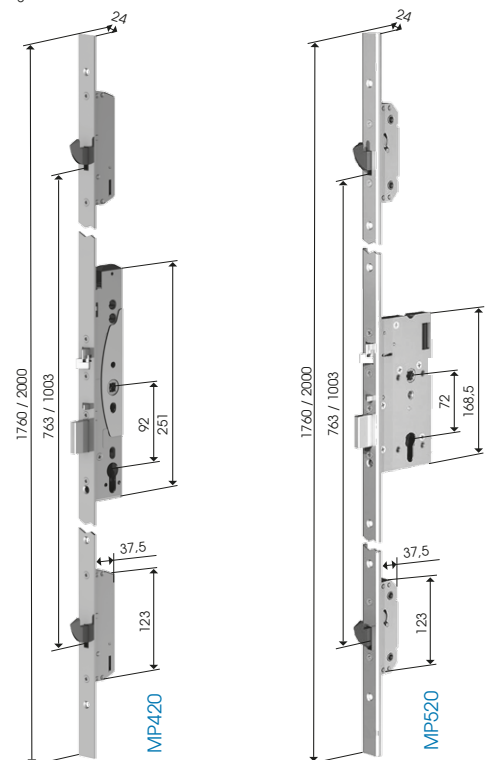

CERTA RANGE SMALL-BUSINESS

The small business category locks provide perfect mechanical security combined with the best features of motor locks. These locks are ideal choice for high-traffic doors, where access control is required, but indication information or door automatics are not necessary. The locks can always be opened by inside handle. Mechanical opening by cylinder is also always possible.

SINGLE POINT LOCK CASES

EL418, EL518

RECOMMENDED PRODUCTS



EA324



EA221



EA281



CY323T



DH004/
040 Ms/Cr

INDICATIONS



STANDARD APPROVALS

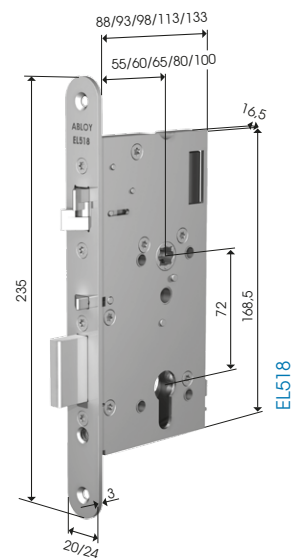
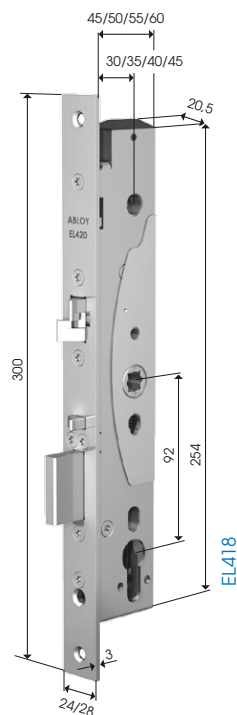

MULTIPOINT LOCK CASES

MP418, MP518

RECOMMENDED PRODUCTS



EA324/
EA306



EA221



EA281



CY323T



DH004/
040 Ms/Cr

INDICATIONS



STANDARD APPROVALS

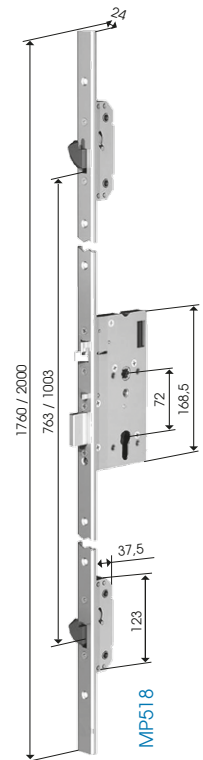
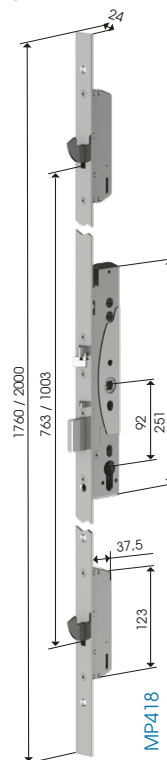

SOLENOID LOCKS

ABLOY offers a full range of solenoid locks for different door styles and applications. The solenoid lock range comprises handle controlled locks in both single point and multipoint locking, but also sophisticated single point lock case with push/pull function.

As a trademark of ABLOY electric locks also Solenoid locks all share the high level of safety and exquisite finishing as a proof of worldwide known premium quality.

For different
door styles and
applications

APPLICATION

ABLOY Solenoid locks are used in the doors that require:

- Safety for EXIT doors, where the inside handle is always in function
- Convenience of push/pull function
- Controlled handle function

Typical applications are offices, meeting rooms and other interior doors of public buildings.

Solenoid lock range includes products for wooden and metal doors and for narrow profile doors as well as multipoint lock cases.

Solenoid locks can be used in exit doors equipped with exit handles, push pads or panic bars depending on the door type. The locks can also be electrically controlled by access control system or by other remote control system such as time control, keypad or push button.

FUNCTION

ABLOY handle controlled locks have two deadlocking bolts: a double action bolt and a deadbolt. The deadbolt is withdrawn inside the lock case and the locking of double action bolt is released by pushing the handle. The locks are always automatically deadlocked when the door is closed.

Handle controlled locks can be set to function as fail locked or as fail unlocked. In the fail locked setting, the lock can be opened by controlled handle when power is on, and can not be opened by controlled handle, when power is off. In the fail unlocked setting, the electrical function is the opposite.

Push/pull function lock has a deadlocking double action bolt, which is released by push pad or by electrical control. The lock with double action bolt can be used in both right- and left-handed doors and in full swing doors.

A close-up photograph of a door handle and lock mechanism. The handle is a long, horizontal metal bar with a textured finish. The lock is a circular metal plate with a keyhole. The background is a blurred view of a building's exterior with windows and a blue sky.

SOLENOID LOCKS HANDLE CONTROLLED

Handle controlled locks are best suited in medium traffic doors. The locks can be electrically controlled by access control system or by a remote control system such as timer, keypad or push button. The locks can be used in emergency exit, panic exit and fire rated doors (EN). The locks are not suitable for use with door automatics.

EL460 and EL560 with split spindle is chosen, when exit by handle is needed. Only outside handle is electrically controlled. The lock can always be opened by inside handle. Mechanical opening by cylinder is always possible

EL461 and EL561 with straight spindle is used, when both access and exit are controlled. Both inside and outside handles are simultaneously controlled and released. Mechanical opening by cylinder or thumbturn is always possible.

EL460, EL461

EL460 and EL461 are used in narrow profile doors.

RECOMMENDED PRODUCTS

				
EA324	EA219	EA281	CY321T	DH004/ 042 Ms/Cr

INDICATIONS



STANDARD APPROVALS

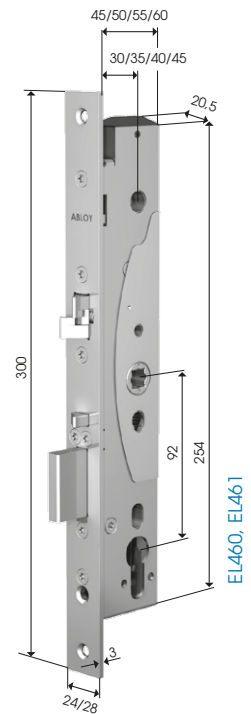

EL560, EL561

EL560 and EL561 are used in wooden and metal doors.

RECOMMENDED PRODUCTS

				
EA324	EA219	EA281	CY321T	DH006/ 042 Ms/Cr

INDICATIONS



STANDARD APPROVALS

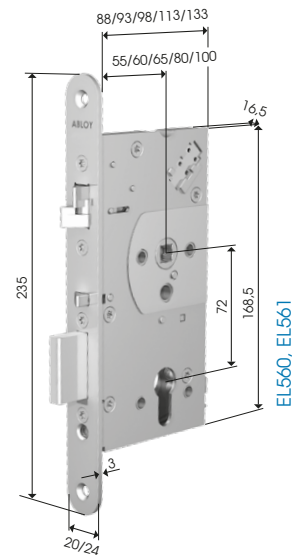

* EL461 and EL561 are not EXIT-approved.

SOLENOID LOCKS

HANDLE

CONTROLLED

MULTIPOINT

LOCKS

Handle controlled locks are best suited in medium traffic doors. They can be electrically controlled by an access control system or by a remote control system such as timer, keypad or push button.

Handle controlled multipoint locks contain main solenoid lock in the middle based on a single point lock of the chosen category and two auxiliary locks with hook bolts. All three lock cases share the same forend and are controlled by the main handle controlled lock in the middle. The multipoint locks are recommended to be used in security doors, fire doors or other doors with higher profile in e.g. storage rooms and technical maintenance rooms.

Handle controlled multipoint locks can be used in emergency exit, panic exit and fire rated doors (EN). The locks are not suitable for use with door automatics.

EL466 and EL566 with split spindle is chosen, when exit by handle is needed. Only outside handle is electrically controlled. The lock can always be opened by inside handle. Mechanical opening by cylinder is always possible.





EL467 and EL567 with straight spindle is used, when both access and exit are controlled. Both inside and outside handles are simultaneously controlled and released. Mechanical opening by cylinder or thumbturn is always possible.









EL466, EL467

EL466 and EL467 are used in narrow profile doors.



RECOMMENDED PRODUCTS

				
EA324+ EA306	EA219	EA281	CY321T	DH006/ 042 Ms/Cr

INDICATIONS

					
---	---	---	---	---	--

STANDARD APPROVALS



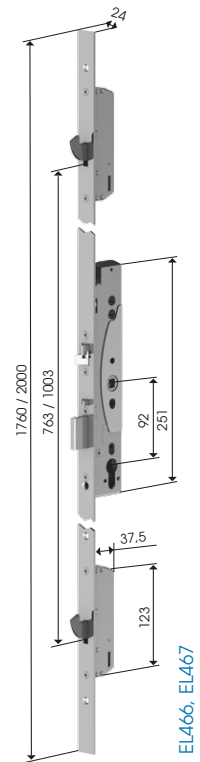

 *	 *	
---	---	---







EL566, EL567

EL566 and EL567 are used in wooden and metal doors.



RECOMMENDED PRODUCTS

				
EA324+ EA306	EA219	EA281	CY321T	DH006/ 042 Ms/Cr

INDICATIONS

					
---	---	---	---	---	--

STANDARD APPROVALS

 *	 *	
---	---	---

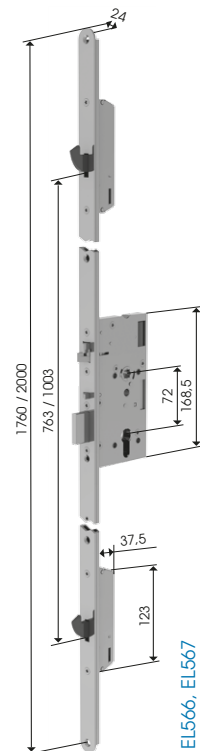

* EL467 and EL567 are not EXIT-approved.

SOLENOID LOCKS

PUSH&PULL

FUNCTION

ABLOY EL404 lock case with double action bolt features an innovative adjustable backset technique. ABLOY EL404 is typically used in narrow profile exterior doors of apartment buildings and interior doors of business premises. The lock has a double action bolt construction for durable and easy use and it offers a cost effective way of electric locking that is highly advantageous in comparison to e.g. electric strike.

ABLOY EL404 can be controlled by a variety of control devices such as card reader, keypad or timer. The lock can be connected to door automatics and is an excellent solution for use with access control systems. Horizontal frame mounting above the door is also possible.

Because of its unique symmetrical trigger bolt ABLOY EL404 can be used in swinging doors.

With EL404 door can be opened by pushing or pulling when electric control is switched on.

EL404 can be configured to operate also fail unlocked, then the door can be opened by pushing or pulling when the electric control is switched off.

Lock can always be opened by key, by thumbturn or by push pad in EXIT doors. For higher security the lock deadlocks automatically when the door closes.

Functional features

- Adjustable backset
- Non-handed, symmetrical trigger bolt
- Immediate release of deadlocking
- Configurable fail locked / fail unlocked
- Wide operating voltage

ABLOY EL404 is not recommended for use in doors with seal force or in fire rated doors.

In swing doors the lock may be locked only when the door has completely stopped in the closed -position.

EL404

RECOMMENDED PRODUCTS



EA308



EA221



EA281



CY323T



DH004/
040 Ms/Cr

INDICATIONS



MECHANICAL / MICROSWITCH LOCKS

DIN range includes also microswitch- and mechanical lock cases with the same dimensions with handle controlled solenoid locks. Both microswitch and mechanical locks share also the same mechanical strength as handle controlled solenoid locks to guarantee the high level of security. Microswitch and mechanical locks are available both in single point and multipoint lock versions.

Microswitch locks are used in doors where door status indications are required but the electric function is not a necessity. Door can be connected to alarm system but not for example to door automatics.

Mechanical locks are used in door environments not requiring any electric functions or indications.

Microswitch and mechanical lock cases are recommended to be used with the inside handle only. The lock can always be opened by inside handle, so these locks can be used in EXIT-doors. Opening from outside by cylinder is always possible.

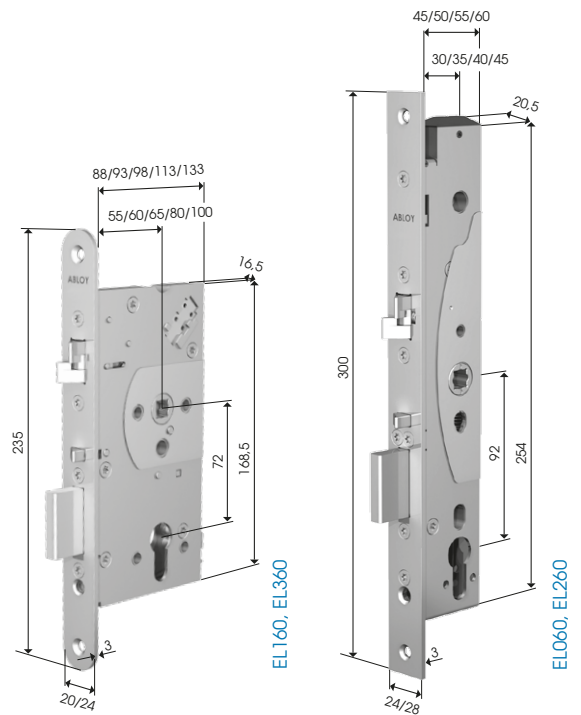

RECOMMENDED PRODUCTS



EA324/
EA306



EA219



EA281



CY321T

* Not used with mechanical locks.

INDICATIONS



Not available with mechanical locks.

STANDARD APPROVALS

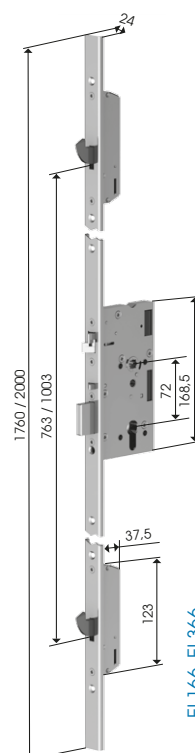

EL166, EL366

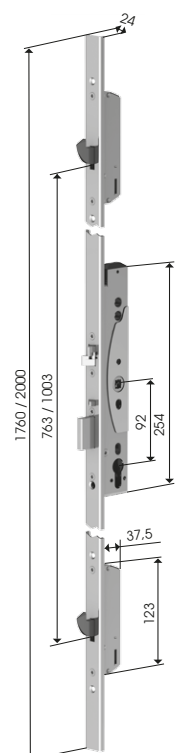

EL066, EL266

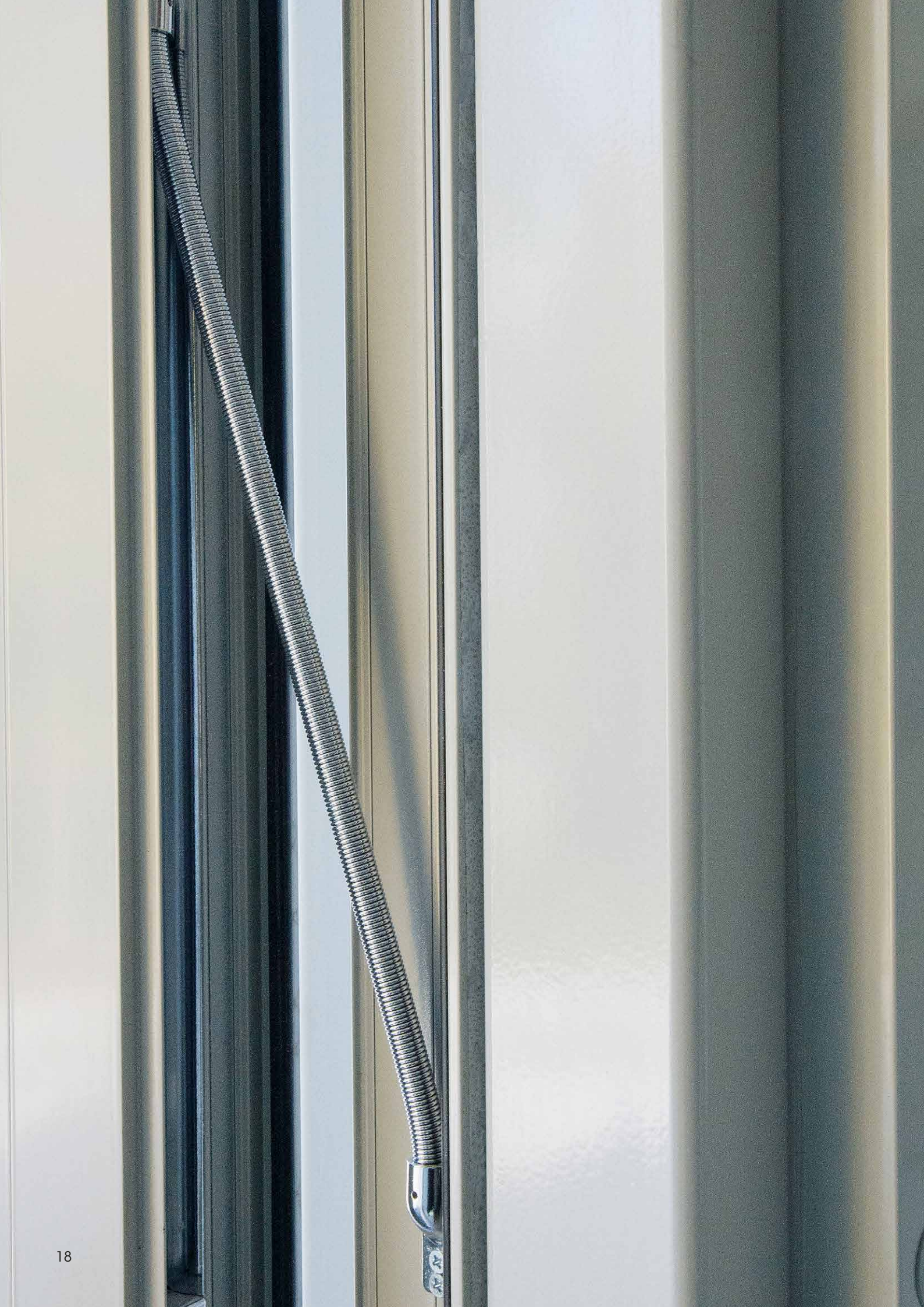

ACCESSORIES

Use original ABLOY accessories to ensure the correct function on the lock and the door environment. The ABLOY electric locks are designed and tested together as a package with ABLOY accessories. Therefore it is highly recommended to use the correct components to ensure the safety and security of the door.

By choosing the model-specific ABLOY striker plate the electric locks work in the door as smoothly and long-lastingly as they are designed to.

ABLOY lead covers assure the safe connection for the cable from door to the frame. Lead covers protect the wires and increase the durability of the cable. Lead covers are available in two versions. EA280 is recommended to doors with maximum opening angle of 120°. The longer version EA281 is recommended to doors with maximum opening angle of 180°.

EN14846

– THE STANDARD FOR ELECTROMECHANICAL LOCKS

All of our DIN Range lock cases are officially tested and approved according to the new standard for electromechanical lock cases. EN14846 combines the mechanical strength tests (former EN12209) with electric testings, which means that the lock cases are now tested more versatile than ever before. As new tests the electric lock standard contains levels of lock status indications and electrical manipulation.

All of the DIN range lock cases are tested according to:

EN14846 standard for electromechanical locks, defines the category of use, mechanical strength and electrical features.

EMC testing for electromagnetic compatibility ensures that products are tested against electric emission and interference.



DIN TECHNICAL COMPATIBILITY CHART







		SOLENOID LOCK CASES								
		EL404	EL460	EL461	EL466	EL467	EL560	EL561	EL566	EL567
CYLINDERS										
	ABLOY PROTEC ² (T)									
	ABLOY NOVEL (U)									
	Single									
	CY321 (T,U)	x	x	x	x	x	x	x	x	x
	CY331 (T,U)	x	x	x	x	x	x	x	x	x
	CY326 (T,U)	x	x	x	x	x	x	x	x	x
	CY336 (T,U)	x	x	x	x	x	x	x	x	x
	Double									
	CY322 (T,U)	x	x	x	x	x	x	x	x	x
	CY332 (T,U)	x	x	x	x	x	x	x	x	x
	CY327 (T,U)	x	x	x	x	x	x	x	x	x
	CY337 (T,U)	x	x	x	x	x	x	x	x	x
	Single w thumbturn									
	CY323 (T,U)	x	x	x	x	x	x	x	x	x
	CY333 (T,U)	x	x	x	x	x	x	x	x	x
	CY328 (T,U)	x	x	x	x	x	x	x	x	x
	CY338 (T,U)	x	x	x	x	x	x	x	x	x
CABLE										
	EA211 (6 m)	x								
	EA218 (6 m)		x	x	x	x	x	x	x	x
	EA230 (6 m)									
	EA221 (10 m)	x								
	EA219 (10 m)		x	x	x	x	x	x	x	x
	EA231 (10 m)									
LEAD COVER										
	EA280	x	x	x	x	x	x	x	x	x
	EA281	x	x	x	x	x	x	x	x	x
STRIKE PLATES										
	For main locks									
	4613	x								
	4614	x								
	EA307	x								
	EA308	x								
	EA311	x								
	EA321		x	x	x	x	x	x	x	x
	EA322		x	x	x	x	x	x	x	x
	EA323		x	x	x	x	x	x	x	x
	EA324		x	x	x	x	x	x	x	x
	EA325		x	x	x	x	x	x	x	x
	EA326		x	x	x	x	x	x	x	x
	EA327		x	x	x	x	x	x	x	x
	EA328		x	x	x	x	x	x	x	x
	EA329		x	x	x	x	x	x	x	x
	EA330		x	x	x	x	x	x	x	x
	EA331		x	x	x	x	x	x	x	x
	EA332		x	x	x	x	x	x	x	x
	LP764									
	For auxiliary locks									
	EA306				x	x			x	x
LP780								x	x	
LP781								x	x	

MOTOR LOCK CASES

EL418	EL420	EL432	MP418	MP420	MP432	EL518	EL520	EL532	MP518	MP520	MP532	EL532HS
X	X	X	X	X	X	X	X	X	X	X	X	X
X	X	X	X	X	X	X	X	X	X	X	X	X
X	X	X	X	X	X	X	X	X	X	X	X	X
X	X	X	X	X	X	X	X	X	X	X	X	X
X	X	X	X	X	X	X	X	X	X	X	X	X
X	X	X	X	X	X	X	X	X	X	X	X	X
X	X	X	X	X	X	X	X	X	X	X	X	X
X	X	X	X	X	X	X	X	X	X	X	X	X
X	X	X	X	X	X	X	X	X	X	X	X	X
X	X	X	X	X	X	X	X	X	X	X	X	X
X	X	X	X	X	X	X	X	X	X	X	X	X
X	X	X	X	X	X	X	X	X	X	X	X	X
X			X			X			X			
	X			X			X			X		
		X			X			X			X	X
X			X			X			X			
	X			X			X			X		
		X			X			X			X	X
X	X	X	X	X	X	X	X	X	X	X	X	X
X	X	X	X	X	X	X	X	X	X	X	X	X
X	X	X	X	X	X	X	X	X	X	X	X	
X	X	X	X	X	X	X	X	X	X	X	X	
X	X	X	X	X	X	X	X	X	X	X	X	
X	X	X	X	X	X	X	X	X	X	X	X	
X	X	X	X	X	X	X	X	X	X	X	X	
X	X	X	X	X	X	X	X	X	X	X	X	
X	X	X	X	X	X	X	X	X	X	X	X	
X	X	X	X	X	X	X	X	X	X	X	X	
X	X	X	X	X	X	X	X	X	X	X	X	
X	X	X	X	X	X	X	X	X	X	X	X	
X	X	X	X	X	X	X	X	X	X	X	X	
X	X	X	X	X	X	X	X	X	X	X	X	
X	X	X	X	X	X	X	X	X	X	X	X	
X	X	X	X	X	X	X	X	X	X	X	X	
X	X	X	X	X	X	X	X	X	X	X	X	
X	X	X	X	X	X	X	X	X	X	X	X	
												X
			X	X	X				X	X	X	
			X	X	X				X	X	X	
			X	X	X				X	X	X	

RECOMMENDED COMBINATIONS

LOCK CASE	CYLINDER	HANDLE
HANDLE CONTROLLED LOCKS		
SOLID SPINDLE	Single	DH004/0750 Ms/Cr
EL461	CY321 (T, U)	
EL467	Double	
EL561	CY322 (T, U)	
EL567		
SPLIT SPINDLE	Single	DH004/042 Ms/Cr
EL460		
EL466	CY323 (T, U)	
EL560		
EL566		
PUSH&PULL FUNCTION LOCKS		
EL404	Single	
EL418/MP418	CY321 (T, U)	DH004/0730 Ms/Cr
EL420/MP420	Double	DH006/0730 Ms/Cr
EL432/MP432	CY322 (T, U)	
EL518/MP518	Single w/thumbturn	DH004/040 Ms/Cr
EL520/MP520	CY323 (T, U)	DH006/040 Ms/Cr
EL532/MP532		
EL532HS		DH628
MECHANICAL/MICROSWITCH LOCKS		
EL360/EL366	Single	DH004/0750 Ms/Cr
EL260/EL266	CY321 (T, U)	DH004/042 Ms/Cr
EL160/EL166	Double	
EL060/EL066	CY322 (T, U)	DH006/0750 Ms/Cr
	Single w/thumbturn	Dh006/042 Ms/Cr
	CY323 (T, U)	

EXIT HANDLE	PANIC BAR	ADDITIONAL INFO
<p>ABLOY® STRATO 13 DH013</p>  <p>ABLOY® FORUM EXIT 4 EH004</p>  <p>ABLOY® POLAR EXIT 6 EH006</p>  <p>ABLOY® PRESTO 3-20 EH060</p> 	<p>PBE011 FOR NARROW STILE, METAL AND WOODEN DOORS</p>  	 <p>Dragon</p> <p>Chrome</p> <p>Satin chrome</p> <p>Antique brass</p> <p>Polished brass</p> <p>Brushed brass</p> <p>White (RAL9010)</p> <p>Black (RAL9005)</p> <p>Aluminum gray (RAL9006)</p> <p>Graphite (RAL790-M)</p> <p>Stainless steel</p> <p>Anodized aluminium</p> <p>ABLOY® ACTIVE</p> <p>ABLOY® ACTIVE</p> <p>ABLOY® ACTIVE</p> <p>ABLOY® ACTIVE</p>



ABLOY secures people, property, and business operations on land, at sea, and in the air – in all circumstances.

ASSA ABLOY is the global leader in door opening solutions, dedicated to satisfying end-user needs for security, safety and convenience.

MANUFACTURER:

Abloy Oy

Wahlforssinkatu 20
P.O. Box 108
FI-80101 Joensuu | Finland
Tel. +358 20 599 2501
WWW.ABLOY.COM



An ASSA ABLOY Group brand **ASSA ABLOY**